

H202

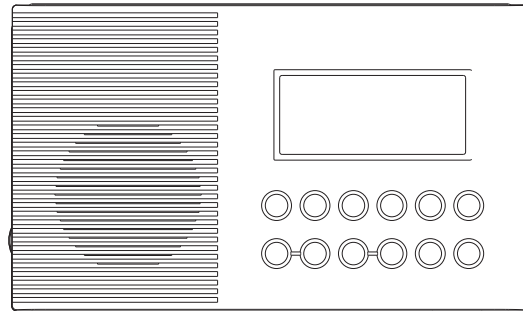

GB

Revision 1

Features

1. Built-in AM/FM antenna for best reception
2. 10 presets (5 each wave band)
3. Water resistant up to JIS7 standard
4. Auto seek stations
5. Large and easy to read LCD display
6. Easy to fix bracket and hanger
7. Battery power indicator
8. Clock
9. Adjustable sleep timer
10. Adjustable short timer
11. Emergency LED illumination (Torch)
12. Emergency Buzzer
13. Water-resistant 3 inches speaker

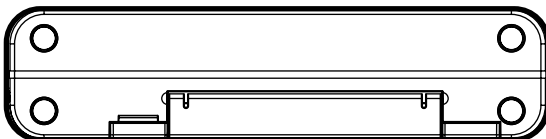
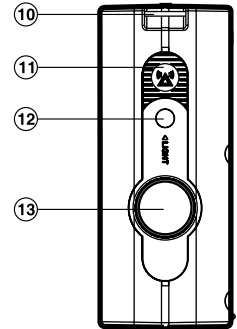
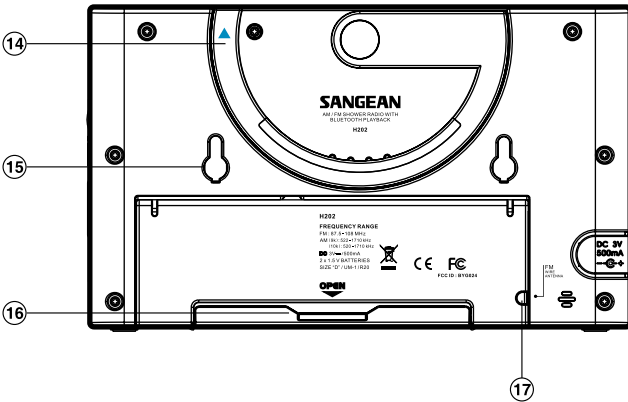
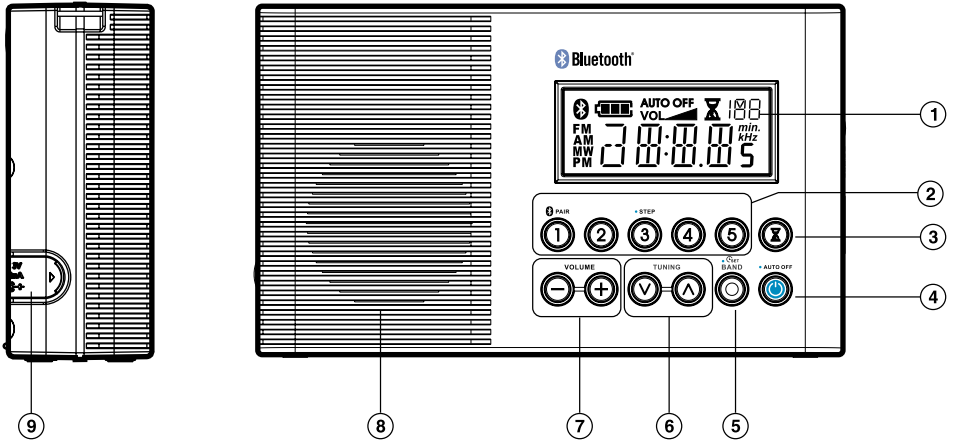

Controls

- ① LCD Display
- ② Preset stations
(preset 1: Bluetooth pair button / preset 3: setting tuning step)
- ③ Nap timer (Short timer)
- ④ Power button
- ⑤ Band and Time Set button
- ⑥ Tuning Control
- ⑦ Volume Control
- ⑧ Speaker
- ⑨ DC IN socket
- ⑩ Hanger Ring
- ⑪ Emergency Buzzer
- ⑫ Torch button
- ⑬ Torch
- ⑭ Multi Purpose Handle
- ⑮ Bracket Holder
- ⑯ Battery Cover
- ⑰ FM wire antenna compartment

GB

LCD Display

- (A) Battery Power Status
- (B) Volume level
- (C) Auto Off status
- (D) Short Timer set
- (E) Memory number and seconds
- (F) Time and Frequency
- (G) Band indicator
- (H) Bluetooth indicator

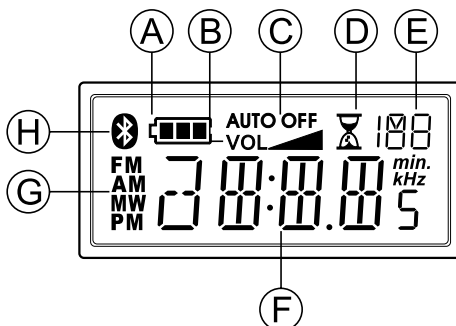

Installing batteries

1. Position the radio face down on a soft surface.
2. Remove the catch as shown and lift out the battery cover.
3. Insert 2 x “D” size/UM-1/LR20 batteries.
4. Replace the battery cover and catch.
5. Reduced power, distortion, a “stuttering” sound are all signs that the batteries may need replacing. The batteries should be replaced when the battery indicator  flashes and E shows in the display.
6. If the radio is not to be used for any extended period of time, it is recommended that the batteries are removed from the radio.

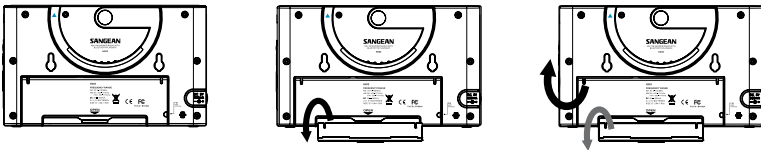

Using the AC adaptor (not supplied)

1. Remove the rubber cover of DC in socket on the left hand side of your radio.
2. Insert the adaptor plug into the DC socket.
3. Plug the adaptor into mains socket outlet. Whenever the adaptor is used, the batteries are automatically disconnected.

GB

The AC adaptor should be disconnected from the mains supply and the radio when not in use.

Note:

For safety purpose, DO NOT use AC adaptor in the shower room. Use the batteries only.

Setting the clock

1. The clock will start running when the batteries are installed or when the radio is connected to the mains supply. The display will show “ - : - - “.
2. The time can be set with your radio switched off or on.
3. Press and hold down the Time Set button  for approx. 2 seconds until the hours digits flash in the display with a beep.
4. Press the Tuning Up/Down buttons to set the required hour.
5. Press the Time Set button, the minute digits will flash in the display.
6. Press the Tuning Up/Down buttons to set the required minute.
7. Press the Time Set button to complete time setting. The second will start to count.

Operating your radio

Your radio is equipped with three tuning methods – Manual Tuning, Search tuning and Memory preset tuning.

Manual Tuning

1. Press the Power button to turn on the radio.
2. Select the required waveband by repeatedly pressing the Band button. For FM waveband, pull out and extend the FM wire antenna located in the battery compartment to get best reception. For MW (AM) waveband, rotate the radio for best reception.
3. A single press on either Tuning up or Tuning down buttons will change the frequency in the following increments:
FM: 100 or 200 kHz (USA version)
50 or 100 kHz (standard version)
AM (MW): 9 or 10 kHz
4. When the waveband end is reached, the radio will continue tuning from the opposite waveband end.
5. Press the Volume Up/Down buttons to the required level.
6. To switch off your radio, press the Power button. The display will show OFF.

Search tuning

1. Press the Power button to turn on the radio.
2. Press the Band button to get required waveband, then extend and position telescopic aerial (FM) or rotate the radio (AM).
3. Press and hold down either Tuning up or Tuning down buttons for more than 0.5 seconds to commence Search tuning.
4. The radio will search and stop automatically when it finds a station of sufficient strength.
5. When the waveband end is reached, the radio will continue tuning from the opposite waveband end .
6. Press the Volume Up/Down buttons to the required level.
7. To switch off your radio, press the Power button. The display will show OFF.

Memory preset tuning

Storing stations in preset memories

There are 5 presets for each waveband.

1. Press the Power button to turn on the radio.
2. Tune to the required station using one of the methods previously described.
3. Press and hold down required preset until the radio beeps (more than 2 seconds). The preset number will appear with a M (memory) and the station will be stored under the chosen preset button.
4. Repeat the procedures for the remaining presets.
5. Stations stored in preset memories may be overwritten by following the above procedures.

Recalling preset stations

1. Press the Power button to turn on the radio.
2. Select the required waveband by pressing the Band button.
3. Momentarily press the required Preset button, the preset number and station frequency will appear in the display.

GB

Software version

The software display cannot be altered and is just for your reference.

1. Turn off the radio.
2. Press the Preset button 3/step button for 2 seconds until the software version number (e.g. P01) shown on the display.

Setting Tuning step

3. After the FM range setting is completed, the display will switch to tuning step setting. Press the Tuning up/down button to choose the desired FM tuning step (50 kHz or 100 kHz) and press the Preset button 3/step button to confirm the setting.
4. After the confirmation of FM tuning step, press the Tuning up/down button to choose the desired AM tuning step (9kHz or 10 kHz) and press the Preset button 3/step button to confirm the setting.

Listening to Bluetooth music

You need to pair your Bluetooth device with your radio before you can auto-link to play/stream Bluetooth music through your H202. Pairing creates a permanent 'bond' so two devices can always recognize each other.

Pairing your Bluetooth device

1. Press the Band button to select Bluetooth function. The Bluetooth icon on the panel will flash with every 3 seconds interval.
2. Activate Bluetooth on your device according to the device's user manual to allow the pairing procedure. With some mobile, you may need to input the pass code "0000".
3. Press and release the Pair button on your H202. Now the Bluetooth icon will flash with 1 second interval. You can start the search of H202 on your Bluetooth device. Once H202 is appeared on your Bluetooth device, press the item in your Bluetooth list and it will link with your H202.
4. Once connected, the Bluetooth icon will remain illuminated. You can now play the music in your Bluetooth-enabled device via H202.

Note:

- a) If there are 2 Bluetooth devices searching for H202, it will show its availability on both devices. However, if one device links with the H202 first, then the other Bluetooth device won't find the H202 on its list.

- b) If your Bluetooth-enabled device is temporarily disconnected to your H202. As long as the disconnection last within 7 minutes, your device can re-connect with your radio again automatically. If the disconnection last more than 7 minutes, then you need to manually reconnect your device again to the radio. Be aware that during the period of disconnection, no other Bluetooth device can pair or link with your radio.
- c) The effective operation range between the docking system and the paired device is approximately 10 meters (30 feet).
- d) Any obstacle between the system and the device can reduce the operational range.

Disconnecting your Bluetooth device

Press and hold the Pair button for 4-5 seconds to disconnect with your Bluetooth device. The Bluetooth icon will then start to flash indicating deactivation of Bluetooth.



Sleep function – Auto Off

The sleep timer will automatically switch off your radio after a pre-set time has elapsed.

1. Press and continue to hold down the Power button, the display will cycle through the available sleep times in the order 50-40-30-20-10-60-50..... Release the button when the required sleep time appears in the display. Display will appear AUTO OFF and radio will play the last station selected.
2. To cancel the sleep function, press the Power button, the AUTO OFF will disappear and the radio will switch off.

Nap timer (short timer)

You can set the Nap timer (short timer) either radio is on or off.

Press Nap timer button , display will appear  and flash last nap timer time. Press Tuning up/down button to select required nap timer time, press Nap timer button again to complete setting.

Nap timer will start to count by second, display will show  and remaining nap timer time (when radio is off). The buzzer will sound for 3 minutes when it reaches the period of time which you have set. Press Power button to turn the buzzer off.

To turn off the Nap timer before the time is up, simply press and release the Nap timer button.  will disappear from display.

You can also memory the nap timer time by long pressing Preset 1-5 button for the timer time you require (same procedures you store the station) and recall it whenever you need to set timer. e.g. you can store 10 minutes timer in preset 1 and 20 minutes timer in preset 2, so each time after you need to select short timer time, press short timer button then preset 1 to get 10 minutes timer and preset 2 to get 20 minutes timer and so on.

Factory reset

If you wish to completely reset your radio to its initial state this may be performed by following this procedure. By performing a factory reset, all user entered settings will be erased.

Press and hold Preset 5 button and the Band button together until 'dEF' shown on the display followed by an beep. Now the factory reset is completed.

Display backlight

The display backlight will be switched on for approximately 15 seconds when any button is pressed.

GB

Emergency buzzer

To activate Emergency buzzer, press and release Emergency buzzer button . Press and release the button again to switch off the buzzer.

Torch

Press to release the torch button  to turn on the torch.



Note:

The torch won't turn off automatically. To turn off the torch, press torch button again.

Multi-purpose handle

Using the multi-purpose handle, you may hang or carry the radio when not used in bathroom.

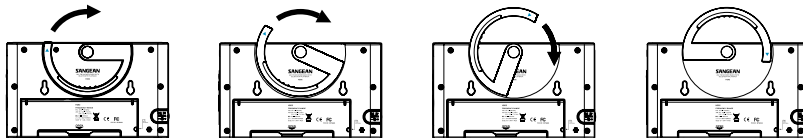

Bracket

You may install the supplied bracket on the wall with the help of the double sides tape back side to hang the radio.

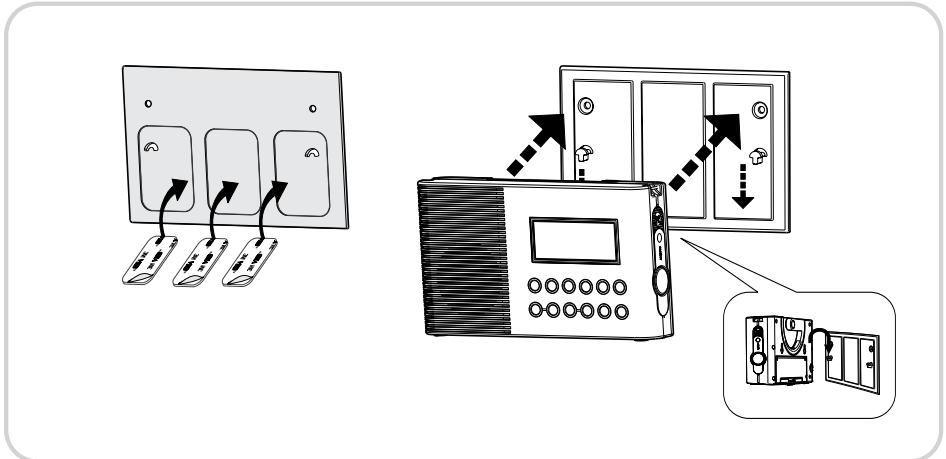
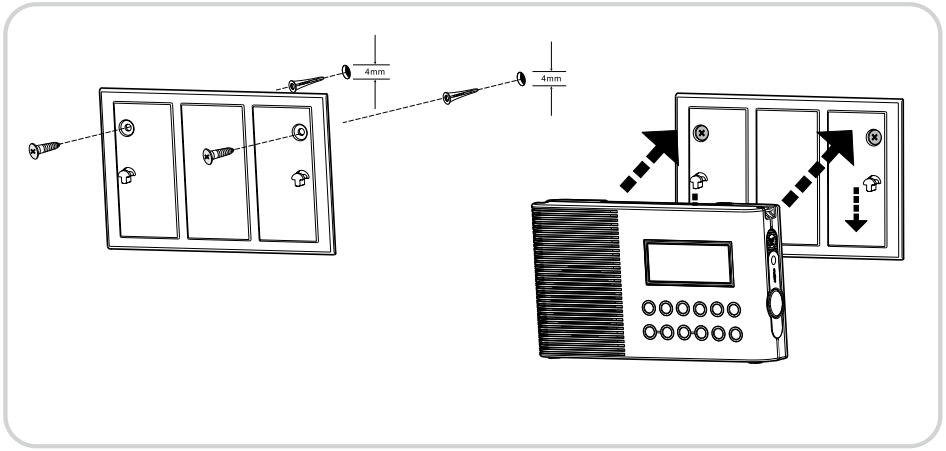

Carrying strap

Using the supplied carrying strap, you may hang or carry the radio when not used in bathroom.

GB

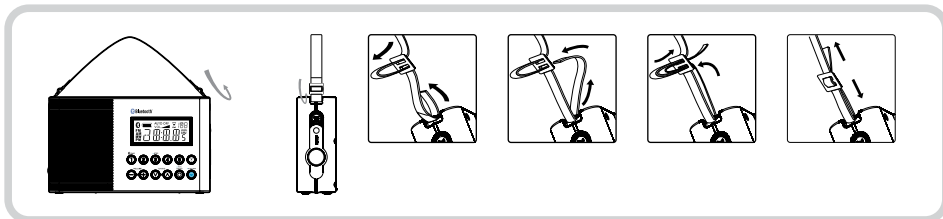

Specifications

Power requirements

Mains via AC adaptor (not supplied)

AC 230 volts, 50 Hz or AC 120 volts, 60 Hz ~ only/DC 3V 500 mA

Batteries: 2 x UM1 (D size, LR20)

Battery Life:

Approx. 120 hours of listening for 4 hours a day at normal volume using alkaline batteries.

Frequency Coverage:

FM 87.50 – 108 MHz

AM (MW) 522 – 1710 kHz or 520 – 1710 kHz

Bluetooth 2.4 - 2.485GHz class-II

Circuit features

Loudspeaker: 3 inches, 8 ohm full range, water resistant

Output Power: 500 mW

Aerial System:

FM Antenna wire

AM (MW) Ferrite Rod

The Company reserves the right to amend the specification without notice.



If at any time in the future you should need to dispose of this product please note that: Waste electrical products should not be disposed of with household waste. Please recycle where facilities exist. Check with your Local Authority or retailer for recycling advice. (Waste Electrical and Electronic Equipment Directive)